



PERFECTION

BUYER'S GUIDE



EN

01-20



"Perfection" stands for our commitment to uncompromising quality, future-oriented manufacturing technologies and maximum customer satisfaction. This I guarantee through our status as a private, independent company.

Gaston Glock, Founder





Table of contents

GLOCK Buyer's Guide





- 06-07 ADVANCED MANUFACTURING
- 08-09 SAFE ACTION® SYSTEM
- 10-11 PISTOL SIZES
- 12-15 GLOCK 44 – 22 l.r.
- 16-17 TECHNOLOGIES
- 18-19 PISTOL OVERVIEW
- 20-21 GEN5
- 22-33 9 mm LUGER
- 24-25 SLIMLINE WITH RAIL
- 26-27 CROSSOVER MODELS
- 30-31 GEN4
- 34-35 40 S&W
- 36-37 MOS (Modular Optic System)
- 38-39 380 AUTO
- 40-41 SLIMLINE
- 42-43 10 mm AUTO
- 44-45 45 AUTO
- 46-47 357 SIG
- 48-49 PREVIOUS
- 50-51 45 GAP
- 52-53 COMPENSATED PISTOLS
- 54-55 CUTAWAY
- 56-57 TRAINING & PRACTICE
- 58-59 MAGAZINES
- 60-63 OPTIONS
- 64-67 ACCESSORIES
- 68-69 OUTDOOR
- 70 ARMORER'S COURSE
- 71 PARTNER PROGRAMS
- 72-74 FAN ITEMS



Advanced Manufacturing

Manufacturing process



Every GLOCK pistol carries 100% GLOCK quality!

By revolutionizing firearms production in the early 1980's, GLOCK became the worldwide leading pistol manufacturer and brought its manufacturing process to perfection.

Full control of raw material

GLOCK has established stringent quality control procedures for internal and external resources. An example of this is the high quality weapon steel being analyzed by the in-house metallurgical department. Only raw materials which comply with the specifications defined by GLOCK are accepted into the production process.

High level of vertical production

Manufacturing activities range from tool making to molding and machining 100% of the components of the final product. Created on the desks of the research and development team, each GLOCK product is immediately linked to the toolmaking department by CAD construction drawings in order to build the necessary tools for the production process. This process includes hammer forging, CNC milling and turning, stamping of strip steel, winding of springs as well as polymer and metal injection molding.





Torture testing

Arctic temperatures or merciless heat, salt water, mud or sand, professionals throughout the world engage in the most hostile environmental conditions and the same is required of their GLOCK pistols. Extensive tests are done in-house during the product design process as well as externally during purchasing procedures. GLOCK pistols prove that they are reliable under tough and adverse conditions. The GLOCK pistol is the weapon of choice for many of officers knowing that their sidearm is one of the most robust and reliable pistols in the world.

Test firing

Every single GLOCK pistol is test fired to ensure CIP conformity as well as flawless function and accuracy out of the box. An electronic target test device was specifically developed for precision testing to align the hit pattern with the line of sight. Every GLOCK customer can ensure they will be receiving a weapon that has been tested in the factory and operates reliably out of the box without compromises or expensive modifications.

Quality Control – Certified production procedures – ISO 9001

GLOCK pistols have been designed to operate without compromise in extreme conditions of police and military use. Thanks to industry leading quality assurance procedures, which are continuously integrated in the production process, tolerances are strictly limited and reliable operational safety is achieved. To bring our quality assurance to perfection, GLOCK is certified according to ISO 9001 – Quality management systems - Requirements.





GLOCK Safe Action® System

REVOLUTIONARY. SAFE. GLOCK.

GLOCK Safe Action® System

GLOCK's revolutionary Safe Action® System provides a consistent trigger pull from the first to the last round. The three automatic, independently operating mechanical safeties, are built into the fire control system of the pistol.

**Every GLOCK pistol comes with 3 independent safeties:
The trigger safety, the firing pin safety and the drop safety**

All three safeties disengage sequentially as the trigger is pulled. They automatically reengage when the trigger is released.





1 Trigger safety

The trigger safety is a lever incorporated into the trigger. When the trigger safety is in the forward position it blocks the trigger from moving rearward. The trigger safety and the trigger must be fully depressed at the same time to fire the pistol. If the trigger safety is not depressed, the trigger will not move rearward and allow the pistol to fire. The trigger safety is designed to protect against firing, if the pistol is dropped or the trigger is subjected to lateral pressure.

2 Firing pin safety

The firing pin safety mechanically blocks the firing pin from moving forward in the ready-to-fire condition. As the trigger is pulled rearward, the trigger bar pushes the firing pin safety up and frees the firing pin channel. If the user decides not to fire and releases the trigger, the firing pin safety automatically reengages.

3 Drop safety

The trigger bar rests on the safety ramp within the trigger mechanism housing. The trigger bar engages the rear portion of the firing pin and prevents the firing pin from moving forward. As the trigger is pulled rearward the trigger bar lowers down the safety ramp and allows the release of the firing pin. After firing, the trigger bar moves upward and reengages the firing pin. As the trigger is released, all safeties automatically reengage.

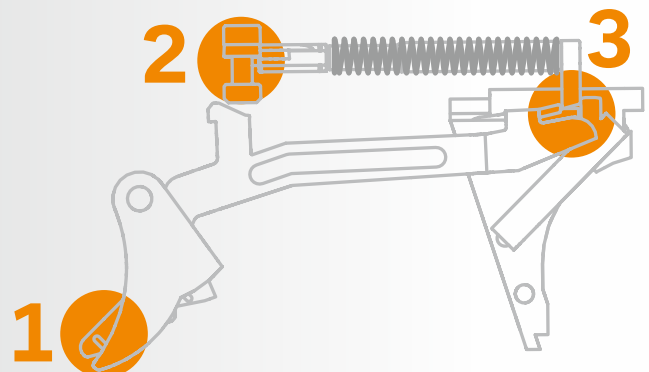



GLOCK Pistol Sizes

Safe Action® Pistols

How to choose the right GLOCK:

Each GLOCK pistol was conceived and designed to accomplish a specific objective. Choosing the optimum solution to best serve your requirements is essential. Therefore GLOCK offers a wide range of handgun dimensions.

The main thing is to find the right model you feel comfortable in action. Try different GLOCK pistols at our local GLOCK Partner to find out which GLOCK fits perfectly in your hands.

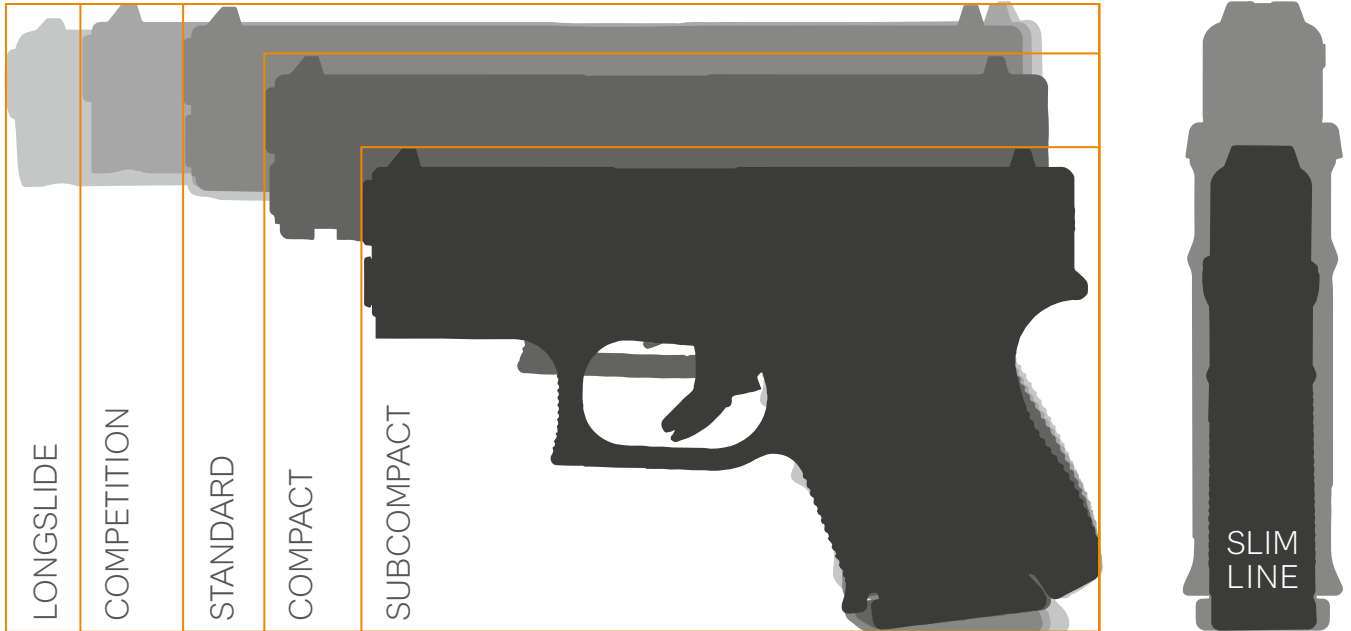

Try before you buy!

With over 50 different models, any GLOCK purchase can be a bit confusing with options ranging from different calibers, sizes, generations and dozens of options for modifying your GLOCK. It may be challenging to find the best pistol on the first purchase. Even seasoned GLOCK users might have difficulties choosing a pistol without hands-on-experience with the different models.

With the GLOCK Partners a pool of retailers was created, who know their GLOCKS and help hundreds of customers annually in choosing their perfect model. Have a look at a variety of models and let an expert explain the advantages of each. Decide what your plans are for your new GLOCK and these partners will know which one will fit you best.



Are you looking for a GLOCK Partner?

Our dealer locator helps you to find a certified GLOCK Partner in your area. Find out more on www.glock.com





STANDARD

The GLOCK classic that thousands of soldiers and law enforcement officers have come to appreciate. Perfect magazine capacity paired with GLOCK dependability.



COMPACT

Slightly reduced in length and height compared to the standard models, this GLOCK offers a good punch in a compact package.



LONGSLIDE

The GLOCK with the longest slide on the market offers the greatest distance between sights, fast target acquisition, and GLOCK-grade performance.



SUBCOMPACT

A pocket-size, double stack pistol designed as a backup weapon. This subcompact gun will accept all standard GLOCK double stack magazines of the same caliber, making it one of the most versatile subcompacts on the market.

COMPACT SLIM

The compact slimline frame combines a comfortable size grip length with a minimal profile for a comfortably balanced versatile grip and a compact length slim slide, ideal for everyday carry.



COMPETITION

With a slightly shorter slide and barrel than the longslide models the GLOCK competition models feature adjustable rear sights and are made for sport shooters who value accuracy and reliability.

SUBCOMPACT SLIMLINE

The concealed-carry choice for thousands. The GLOCK single stack slimline pistols are the smallest GLOCK pistols with the same trusted accuracy and reliability.

CROSSOVER DESIGN

A shorter slide and a longer frame create a crossover size and join forces in order to provide a comfortably balanced grip and higher magazine capacity paired with reduced weight to increase comfort.



GLOCK 44 Technology

Rimfire Pistol

NEW  22 l.r.



GLOCK 44

LIGHTWEIGHT AND SMOOTH TO SHOOT.

Once you start with perfection – you stay with perfection. The G44 is the ideal pistol to start your shooting career at the range. The perfect mix of polymer and steel gives the experience of shooting a GLOCK pistol while handling a lightweight low recoil handgun. The G44 is a compact size pistol you can adapt to nearly every hand size by using the different backstraps supplied with the pistol.



G44

			
POLYMER-STEEL HYBRID SLIDE FOR LESS WEIGHT AND RECOIL & NEW ADJUSTABLE SLIM REAR SIGHT		GLOCK MARKSMAN BARREL FOR HIGH PRECISION & GHOST HOLE - TO CHECK IF A CARTRIDGE IS CHAMBERED	
			
CONTROLS FOR LEFT AND RIGHT HANDED SHOOTERS & SAFE ACTION® SYSTEM FOR RELIABLE SAFETY		POLYMER FRAME ADAPTABLE FOR NEARLY EVERY HAND SIZE & 10 ROUNDS MAGAZINE WITH INTEGRATED LOADING ASSIST	



22 l.r.

Safe Action® Pistols



GLOCK 44

10 COMPACT

REAL GLOCK. NEW CALIBER. EXPERIENCE 22 l.r.

The G44 is the perfect fit for inexperienced as well as for advanced shooters. It is tested with a broad range of ammunition and its GLOCK Marksman barrel stands for high precision.

The right equipment is essential, the G44 comes with adjustable slim polymer rear sights, two magazines with loading assist, a screwdriver for the sights, a new cleaning kit for the smaller barrel and a set of backstraps with and without beavertail. Everything a well prepared shooter needs.

Optional a configuration of this model with threaded barrel (M9x0,75) and adapter for .500-28 UNEF is available.

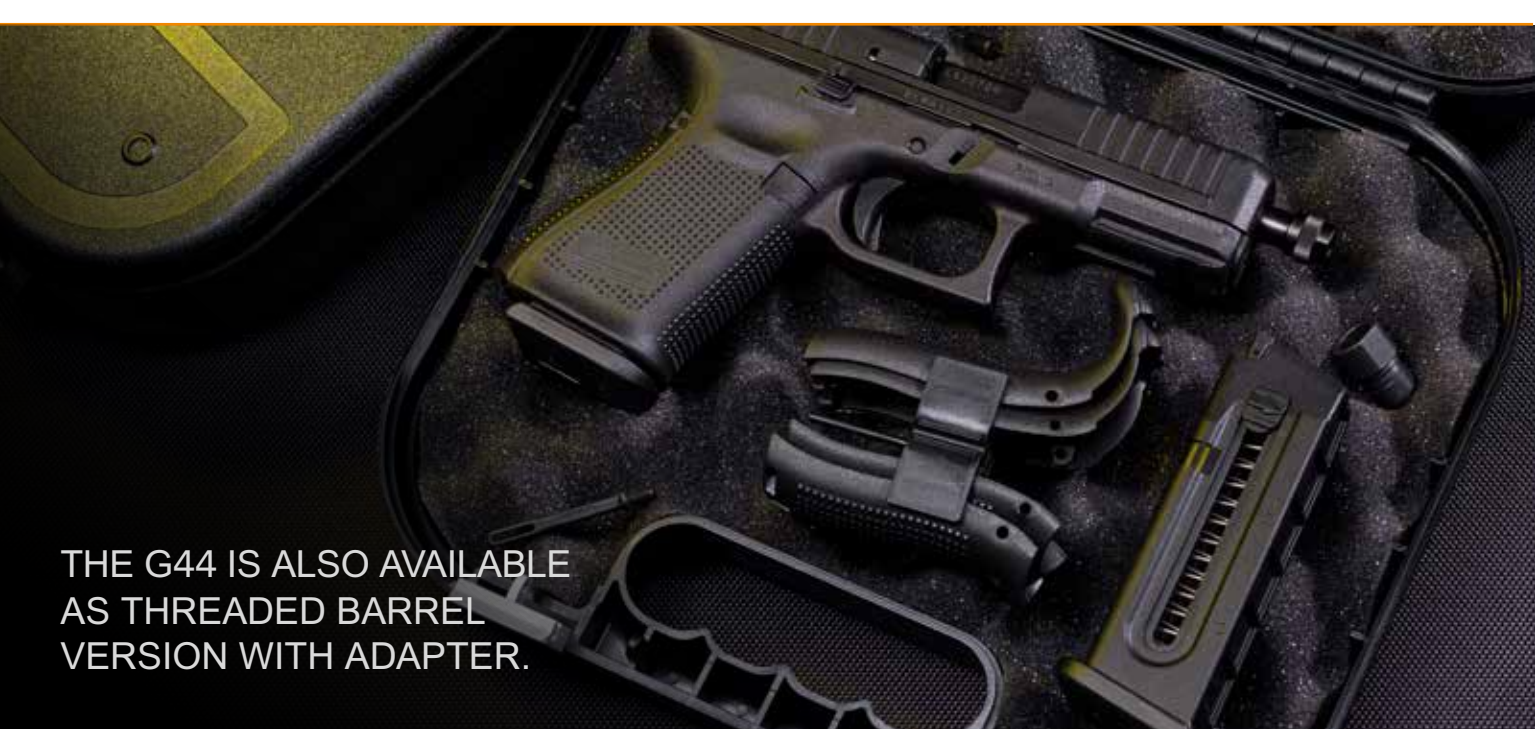

THE G44 IS ALSO AVAILABLE AS THREADED BARREL VERSION WITH ADAPTER.

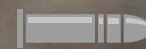
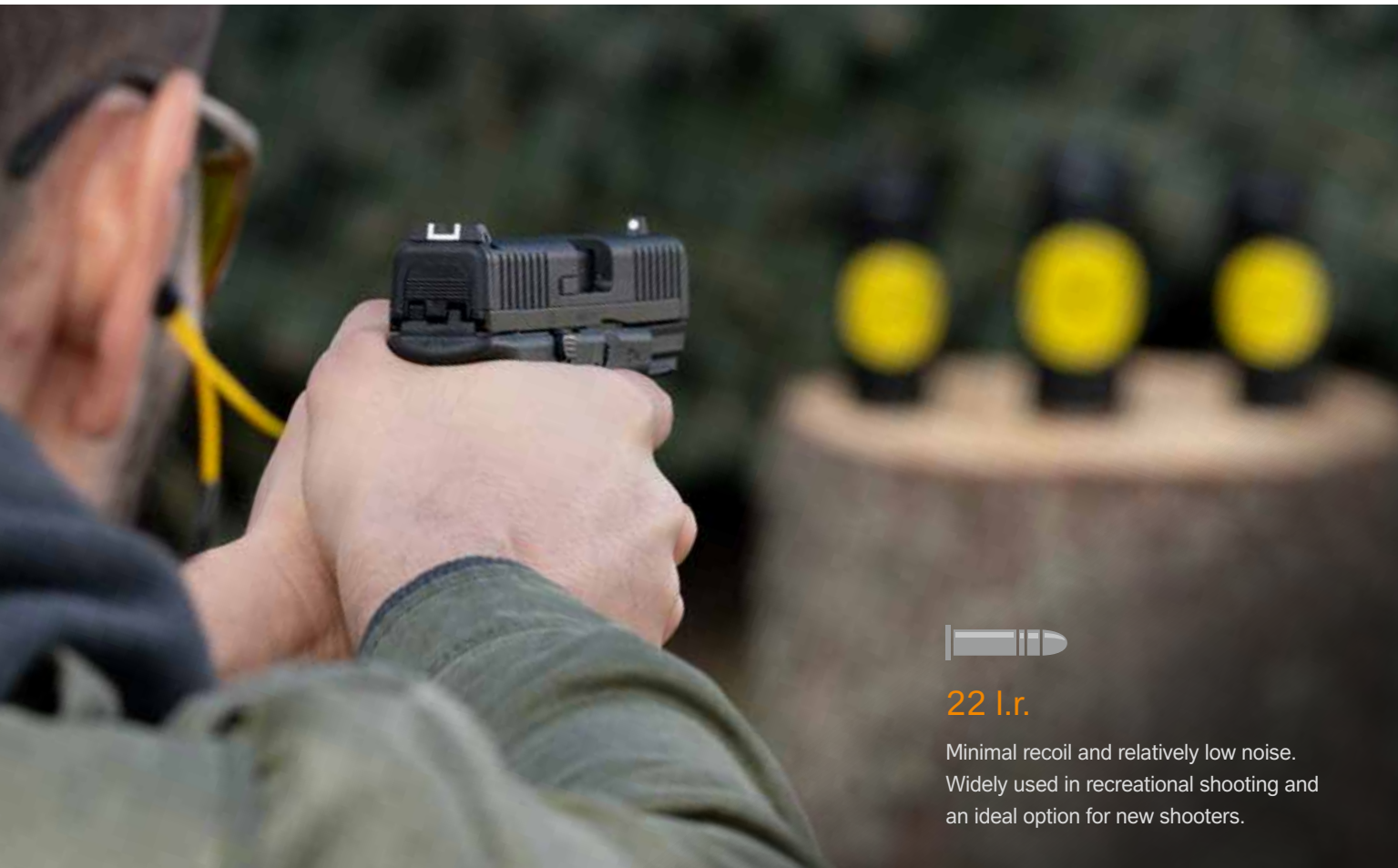

22 l.r.

Minimal recoil and relatively low noise.
Widely used in recreational shooting and
an ideal option for new shooters.

TECHNICAL DATA

G44

SYSTEM	SAFE ACTION® (constant double action mode), all GLOCK pistols come with 3 safeties	
CALIBER	22 l.r.	
*LENGTH (OVERALL)	185 mm	7.28 inch
SLIDE LENGTH	174 mm	6.85 inch
BARREL LENGTH	102 mm	4.02 inch
WIDTH (OVERALL)	32 mm	1.26 inch
SLIDE WIDTH	25,5 mm	1.00 inch
HEIGHT INCL. MAGAZINE	128 mm	5.04 inch
WEIGHT w/o MAGAZINE	358 g	12.63 oz
WEIGHT w. empty MAGAZINE	418 g	14.7 oz
**WEIGHT w. loaded MAGAZINE	453 g	15.98 oz
*TRIGGER DISTANCE	70 mm	2.76 inch
TRIGGER PULL (~)	26 N	
SIGHT RADIUS	158 mm	6.22 inch
MAGAZINE CAPACITY	10	

*Dimensions for medium backstrap w/o beavertail (+2 mm | 0.08 in.) and for large backstrap w/o beavertail (+4 mm | 0.16 in.)

** Depending on ammunition.

Technical data are rounded and do not reflect tolerances – they may be altered without notice.



Technology tags – LISTING ADDITIONAL AVAILABILITIES

*for details on availability check with www.glock.com or your local dealer

	Gen5	Gen5 MOS	Gen4 MOS	Gen4
 SAFE ACTION® SYSTEM	✓	✓	✓	✓
 LOADED CHAMBER INDICATOR	✓	✓	✓	✓
 POLYMER FRAME	FLARED FRAME (EXCEPT G26 GEN5) – NO FINGER GROOVES	FLARED FRAME – NO FINGER GROOVES	✓	✓
 MOUNTING RAIL	✓	✓	✓	✓
 GEN4 RTF (ROUGH TEXTURED FRAME)	✓	✓	✓	✓
 CUSTOMIZABLE FRAME SIZE	✓	✓	✓	✓
 REVERSIBLE MAGAZINE CATCH	✓	✓	✓	✓
 AMBIDEXTROUS SLIDE STOP LEVER	✓	✓		
 SLOT FOR LANYARD CLIP*	✓	✓	✓	✓

Available models:
G17 Gen5, G19 Gen5, G26 Gen5, G45

For G44 technology refer to pages 12-15.

Available models:
G17 Gen5 MOS, G19 Gen5 MOS, G34 Gen5 MOS, G45 MOS

G17 Gen4 MOS, G19 Gen4 MOS, G34 Gen4 MOS, G35 Gen4 MOS, G40 Gen4 MOS, G41 Gen4 MOS

Available models:
G17 Gen4, G19 Gen4, G20 Gen4, G21 Gen4, G22 Gen4, G23 Gen4, G26 Gen4, G27 Gen4, G29 Gen4, G30 Gen4, G31 Gen4, G32 Gen4, G33 Gen4, G34 Gen4, G35 Gen4, G40 Gen4, G41 Gen4

Slimline

Previous

Available models:
G42, G43, G43X, G48

Available models:
G17, G19, G20, G21, G22, G23,
G24, G25, G26, G27, G28, G29,
G30, G31, G32, G33, G34, G35,
G36, G37, G38, G39

✓	✓
✓	✓
✓ NO FINGER GROOVES, BUILT-IN BEAVERTAIL	✓
✓ EXCEPT G42, G43, SILVER SLIDE MODELS	✓ EXCEPT G26, G27, G33, G39
SPECIAL GRIP TEXTURE FOR SLIMLINE	
✓	
	✓

FS

Pistols with Front Serrations (FS) offer the advantage for the operator to do a fast press check through an additional tactile surface.

C

The compensated (C) GLOCK pistol models are equipped with an integrated compensator to improve hit patterns during rapid firing.

SF

SF pistols come with a shortened frame (SF) with reduced grip dimensions and shorter trigger distance. (only Previous generation)

S

The slides of S pistols feature slimmer (S) slide widths. (only Previous generation)

CROSSOVER

Crossover pistols combine a shortened slide with a longer frame in order to reach higher magazine capacity paired with reduced weight to increase comfort.



GLOCK Pistol Models Overview

Safe Action® Pistols

CHOOSE YOUR GLOCK!

STANDARD

COMPACT

COMPACT CROSSOVER

SUBCOMPACT

9 mm Luger



22-33

G17



G19



G19X/G45



G26



9 mm Luger



22-33

G48 Rail

COMPACT SLIMLINE



40 S&W



34-35

G22



G23



G27



380 Auto



38-39

G25



G28



10 mm Auto



42-43

G20



G29



45 Auto



44-45

G21



G30



357 SIG



46-47

G31



G32



G33



45 GAP



50-51

G37



G38



G39



SUBCOMPACT
SLIMLINE

COMPETITION

LONG SLIDE



G43



G34



G17L



G43X Rail



G35



G24



G42



G40



G36



G41

Learn more about the **compact G44** in 22 l.r. on pages 12-15.

NEW

**Special Training
& Practice Pistols**



Cutaway
54-55



Training
56



Practice
57



Reset
57



MODULAR OPTIC SYSTEM
CONFIGURATION

GLOCK pistols in MOS
configuration on pages 36-37.



GLOCK Gen5

THE NEXT GENERATION

GEN 5

The generation 5 combines the technology of the future with improved precision, versatility, speed and the familiar reliability of GLOCK!

ENHANCED GRIP

Front serrations for fast press checks

TECHNOLOGY OF THE FUTURE

nDLC finish for barrel and slide

ACCURACY

GLOCK "Marksman" Barrel





GEN5

nDLC FINISH ON BARREL AND SLIDE & FRONT SERRATIONS, GLOCK "MARKSMAN" BARREL	
AMBIDEXTROUS SLIDE STOP LEVER & REVERSIBLE MAGAZINE CATCH	
FLARED MAG-WELL & ENLARGED MAGAZINE FLOOR PLATE	
REMOVAL OF THE FINGER GROOVES & BACKSTRAP AND BEAVERTAIL SYSTEM	

VERSATILITY

Removal of the finger-grooves on the grip

SPEED

Flared magwell



9 mm Luger

Safe Action® Pistols



GLOCK 17 Gen5

17 STANDARD GEN5 MOS

THE NEWEST GENERATION OF THE ORIGINAL

The new frame design of the GLOCK 17 Gen5 removed the finger grooves for more versatility but still allows to easily customize its grip by using the different backstraps. A flared mag-well give the user more speed during reloading when fractions of a second matter. A reversible magazine catch, changeable at user level as well as the ambidextrous slide stop lever accommodate left and right-handed operators. The rifling and the crown of the barrel were slightly modified for increased precision.

Also available as G17 Gen5 MOS



GLOCK 19 Gen5

THE NEXT GENERATION

The GLOCK 19 Gen5 pistol in 9 mm Luger is ideal for a more versatile role due to its reduced dimensions. The new frame design without finger grooves still allows to instantly customize its grip to accommodate any hand size by mounting the different back straps. The reversible magazine catch and ambidextrous slide stop lever make it ideal for left and right-handed shooters. The rifling and the crown of the barrel were slightly modified for increased precision.

Also available as G19 Gen5 MOS



15 COMPACT GEN5 MOS

GLOCK 34 Gen5 MOS FS

The GLOCK 34 Gen5 MOS features an extended barrel and greater slide dimensions, making it a favorite among sport shooting competitors. Design enhancements include the GLOCK Marksman Barrel (GMB) which delivers increased accuracy with enhanced polygonal rifling and an improved barrel crown, no finger grooves, ambidextrous slide stop levers for better versatility and control, and an nDLC finish, which is a tougher and more durable finish that is exclusive to the GLOCK manufacturing process.

Only available as G34 Gen5 MOS



Optic not included!

17	COMPETITION	GEN5	MOS
----	-------------	------	-----



GLOCK 26 Gen5

10	SUBCOMPACT	GEN5
----	------------	------



ADDITION TO THE GEN5 PISTOL FAMILY

The GLOCK 26 Gen5 is a popular option for concealed carry and features the GLOCK Marksman Barrel (GMB), delivering increased accuracy with enhanced polygonal rifling as well as an improved barrel crown. Other features include removal of the finger grooves, an ambidextrous slide stop lever and nDLC finish.

SAME SIZE – DIFFERENT CALIBER





9 mm Luger

Safe Action® Pistols

THE ALL-BLACK SLIMLINE PISTOLS

The GLOCK 43X and the GLOCK 48, are now available in an all-black factory finish. The G43X and G48 both feature a Slimline compact design for comfort, durability and reliability. Chambered in 9 mm Luger, both pistols feature a compact Slimline frame with a slim mounting rail and a black slide with nDLC finish as well as a 10-round magazine capacity making them ideal for concealed carry.

NEW SLIMLINE



BALANCED

The perfect fit for nearly all hand sizes

ACCESSORIES

Mounting rail slim for tactical lights

COMFORTABLE

Built-in Beavertail Design



GLOCK 43X Rail

🔒 10
SUBCOMPACT SLIMLINE
SLIM

CONCEALED CARRY WITH 10 ROUNDS

The G43X Rail has the same compact size grip length with a minimal profile and a built in beavertail as the G48 for a comfortably balanced, versatile grip that's ideal for a variety of users. The magazine capacity of the slim 01 magazine of the G43X is 10 rounds.



GLOCK 48 Rail

🔒 10
COMPACT SLIMLINE
SLIM

THE PERFECT FIT FOR NEARLY ALL HAND SIZES

The G48 Rail in caliber 9 mm Luger is of similar length and height as the G19 but the width of the pistol is reduced for increased concealability and high carrying comfort. The magazine capacity of the slim 01 magazine of the G48 is 10 rounds.

G43X & G48



ALSO AVAILABLE WITH:
SILVER nPVD COATING



MOUNTING RAIL SLIM
WITH TACTICAL LIGHT



GLOCK SLIM 01 MAGAZINE



9 mm Luger

Safe Action® Pistols



GLOCK 19X

17 COMPACT CROSSOVER CROSSOVER

SUBMISSION FOR THE US ARMY

GLOCK's first ever "Crossover" pistol, the GLOCK 19X, combines the best features of two of its most popular and most trusted field-tested platforms. The full-size GLOCK 17 frame and the compact GLOCK 19 slide have joined forces to produce the ideal pistol for all conditions and all situations. The G19X comes in the coyote color with the first-ever factory colored slide, finished with an improved nPVD slide coating to prevent corrosion. Additional features include the GLOCK Marksman Barrel (GMB), no finger grooves, ambidextrous slide stop levers and lanyard loop. Included with the pistol is a standard 17-round magazine, two 17+2-round magazines and a coyote-colored pistol case.



GLOCK 45

17 COMPACT CROSSOVER GEN5 CROSSOVER MOS

COMPACT CROSSOVER IN BLACK

The G45 is a 9 mm Luger Crossover Pistol which combines a compact slide with a full-size frame. Like the G19X, the G45 incorporates engineering and design advancements developed by GLOCK to meet military and Law Enforcement specifications. However, unlike the G19X, the G45 also features the flared mag-well found on GLOCK's popular Gen5 pistols, and is an ideal pistol for law enforcement and private owners.



Also available as G45 MOS

CROSSOVER MODELS

The G19X & G45 combine the full-size G17 frame with a compact G19 slide. This makes them accessible to every type of shooter.

CROSSOVER MODELS





9 mm Luger

Safe Action® Pistols

GLOCK 17 Gen4

The Modular Back Strap design of the GLOCK 17 Gen4 allows one to easily customize its grip to add comfort, regardless of the shooter's hand size. The surface of the frame features the new Gen4 rough textured profile. Internally, the new GLOCK dual recoil spring assembly substantially reduces the wear and tear on the system. A reversible enlarged magazine catch, changeable at user level accommodates left and right-handed operators.

Also available as: GLOCK 17 Gen4 MOS, GLOCK 17



- 17
- STANDARD
- GEN4**
- MOS
- PREVIOUS

GLOCK 19 Gen4

The GLOCK 19 Gen4 pistol in 9 mm Luger offers great firepower while allowing to shoot quick and accurately. It is ideal for a more versatile role due to its reduced dimensions, without sacrificing all-important magazine capacity. The modular back strap system makes it possible to instantly customize its grip to accommodate any hand size. The reversible magazine catch makes it ideal for left and right-handed shooters.

Also available as: GLOCK 19 Gen4 MOS, GLOCK 19



- 15
- COMPACT
- GEN4**
- MOS
- PREVIOUS

GLOCK 26 Gen4

The GLOCK 26 Gen4 in 9 mm Luger is one of the most sought-after concealed carry pistols. The magazine capacity of 10 rounds is standard and the highly accurate firing characteristics explain why the G26 Gen4 is the mainstay backup option among security personnel and agencies worldwide. Of course, the G26 Gen4 comes with a reversible magazine catch, interchangeable back straps and improved frame texturing for solid control despite the pistol's size.

Also available as: GLOCK 26



- 10
- SUBCOMPACT
- GEN4**
- PREVIOUS

GLOCK 34 Gen4 MOS

The GLOCK 34 Gen4 in MOS configuration combines an extended barrel and slide and elongated distance between sights with the MOS concept, making it easy to mount a reflex sight on the pistol's slide without the need for a new slide or separate mounting system. The Modular back strap system makes it possible to instantly customize its grip to accommodate any hand size. The reversible magazine catch makes it ideal for left and right-handed shooters.

Also available as: GLOCK 34 Gen4, GLOCK 34



Optic not included!

- 17
- COMPETITION
- GEN4**
- MOS**
- PREVIOUS

GLOCK 17L

The GLOCK 17L is an ideal competition pistol with a long barrel, a slotted and accurately balanced slide, long sight radius and a slightly lighter trigger pull for ultimate precision.



- 17
- LONG SLIDE
- PREVIOUS**



9 MM LUGER

Proven ballistic performances, moderate recoil, worldwide distribution.





GLOCK Gen4

Safe Action® Pistols

GEN

4

Every GLOCK Gen4 comes with backstraps in two sizes each one with or without beaver tail. The multiple backstrap frame allows the user to change the circumference of the grip to fit their individual hand size.

The Gen4 has a new rough textured frame (Gen4 RTF) surface designed to enhance grip traction, without being too aggressive. It is present on the frame as well as on the interchangeable backstraps.

The magazine catch of the Gen4 frame is reversible and enlarged towards the rear of the pistol. The reversible magazine catch is more user friendly to the shooter's reach and allows them to switch the catch to the left or right side of the pistol.

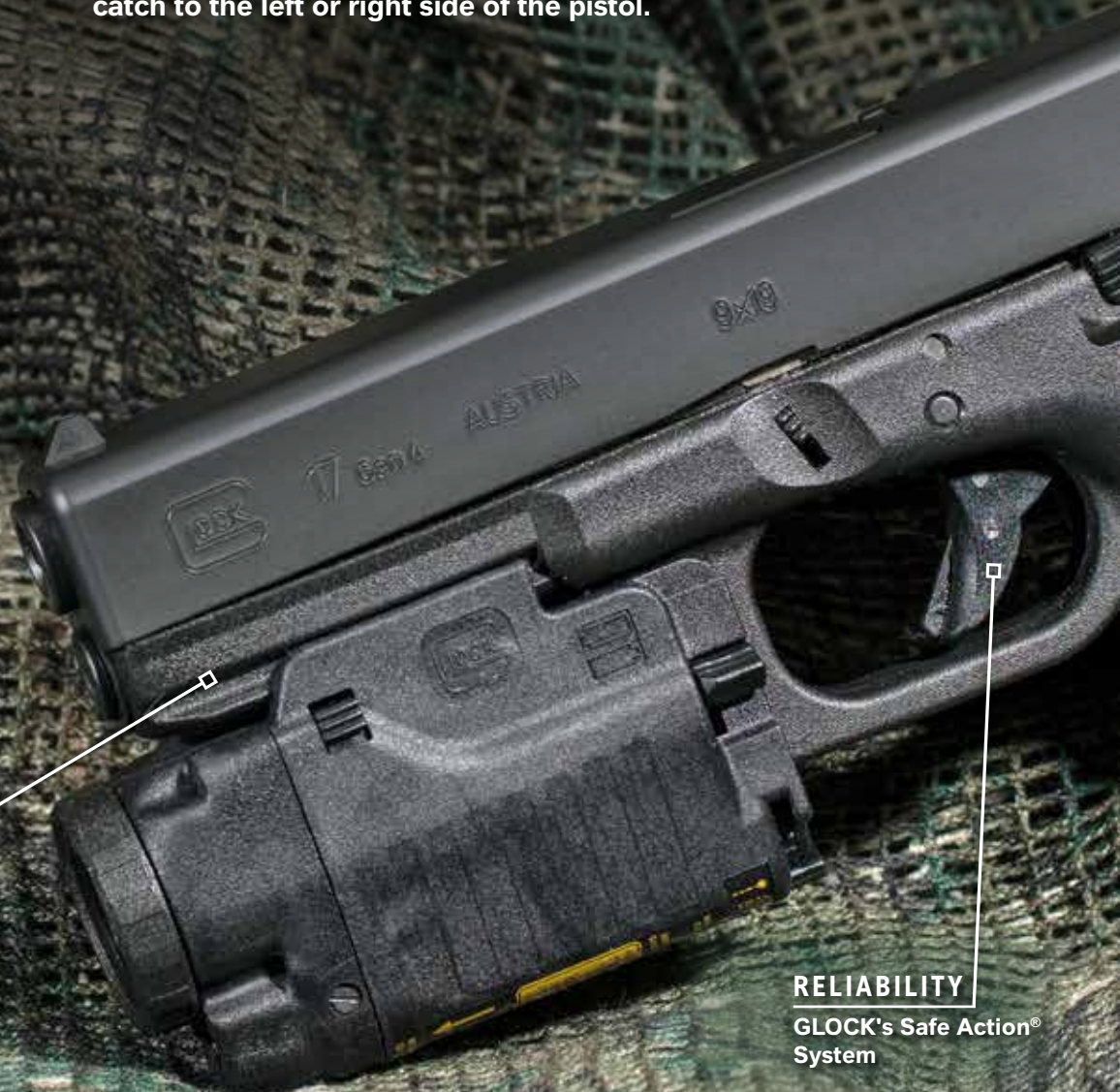

ACCESSORIES

Mounting rail for tactical lights and lasers

RELIABILITY

GLOCK's Safe Action® System



ERGONOMIC DESIGN
Backstrap and beavertail-system

USER FRIENDLY
Reversible magazine
catch

GEN4 RTF
Rough textured frame

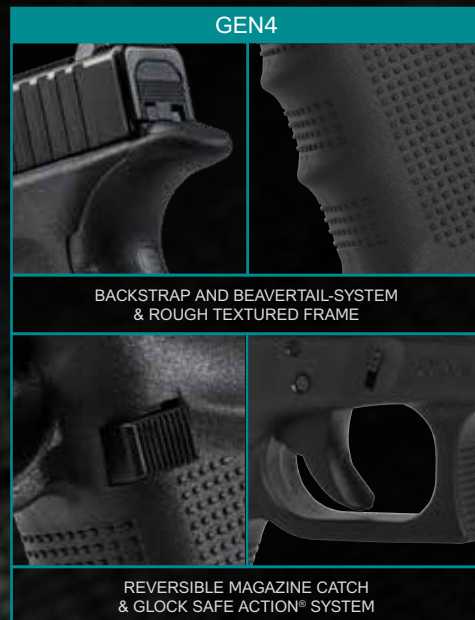

GEN4



BACKSTRAP AND BEAVERTAIL-SYSTEM
& ROUGH TEXTURED FRAME

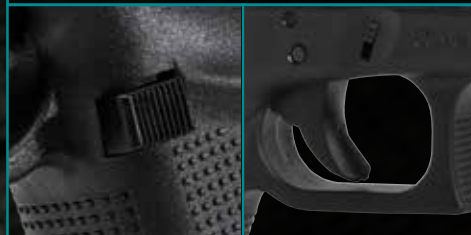

REVERSIBLE MAGAZINE CATCH
& GLOCK SAFE ACTION[®] SYSTEM



9 mm Luger

Safe Action® Pistols



GLOCK 43

6

SUBCOMPACT SLIM

SLIM

The already legendary G43 is a single stack style, 9 mm Luger caliber pistol. It is ultra-concealable, accurate and a fantastic tool for all shooters regardless of one's hand size. The grip has a built-in beaver tail design which allows the shooter to acquire a high and tight grip. The texture of the grip surface allows a comfortable and reliable operation of the pistol. The large magazine catch makes quick work of removing the six round magazine. Engineered based on the same demanding standards that GLOCK is famous for, the tiny G43 tolerates the same torture tests all its bigger brothers in the GLOCK pistol family withstand.



TECHNICAL DATA

G17 GEN5*

G17 L

G19 GEN5*

G26 GEN5

SYSTEM	SAFE ACTION® (constant double action mode), all GLOCK pistols come with 3 safeties							
CALIBER	9 mm Luger							
*LENGTH (OVERALL)	202 mm	7.95 inch	242 mm	9.53 inch	185 mm	7.28 inch	163 mm	6.42 inch
SLIDE LENGTH	186 mm	7.32 inch	225 mm	8.86 inch	174 mm	6.85 inch	159 mm	6.26 inch
BARREL LENGTH	114 mm	4.49 inch	153 mm	6.02 inch	102 mm	4.02 inch	87 mm	3.43 inch
WIDTH (OVERALL)	34 mm	1.34 inch	33 mm	1.30 inch	34 mm	1.34 inch	33 mm	1.30 inch
SLIDE WIDTH	25,5 mm	1.00 inch	25,5 mm	1.00 inch	25,5 mm	1.00 inch	25,5 mm	1.00 inch
HEIGHT INCL. MAGAZINE	139 mm	5.47 inch	139 mm	5.47 inch	128 mm	5.04 inch	106 mm	4.17 inch
WEIGHT w/o MAGAZINE	630 g	22.22 oz	675 g	23.81 oz	610 g	21.52 oz	559 g	19.72 oz
WEIGHT w. empty MAGAZINE	708 g	24.97 oz	755 g	26.63 oz	670 g	23.63 oz	615 g	21.69 oz
**WEIGHT w. loaded MAGAZINE	911 g	32.14 oz	960 g	33.86 oz	888 g	30.16 oz	739 g	26.07 oz
*TRIGGER DISTANCE	70 mm	2.76 inch	72 mm	2.83 inch	70 mm	2.76 inch	70 mm	2.76 inch
TRIGGER PULL (~)	26 N		24 N		26 N		26 N	
SIGHT RADIUS POLYMER	165 mm	6.50 inch	205 mm	8.07 inch	153 mm	6.02 inch	137 mm	5.39 inch
SIGHT RADIUS STEEL	164 mm	6.46 inch	204 mm	8.03 inch	152 mm	5.98 inch	136 mm	5.35 inch
SIGHT RADIUS GNS	163 mm	6.42 inch	203 mm	7.99 inch	151 mm	5.94 inch	135 mm	5.31 inch
MAGAZINE CAPACITY	17		17		15		10	

*For Gen4/Gen5 Models: Dimensions for medium backstrap w/o beavertail (+2 mm | 0.08 in.) and for large backstrap w/o beavertail (+4 mm | 0.16 in.)

** Depending on ammunition. +Technical data also applicable for MOS configuration.

Technical data are rounded and do not reflect tolerances – they may be altered without notice.

Technical data of the different generations **GEN5** **GEN4** **PREVIOUS** and technical configurations of the same model are mostly similar.

TECHNICAL DATA	G34 GEN5+		G19 X		G45+	
SYSTEM	SAFE ACTION® (constant double action mode), all GLOCK pistols come with 3 safeties					
CALIBER	9 mm Luger					
*LENGTH (OVERALL)	222 mm	8.74 inch	189 mm	7.44 inch	189 mm	7.44 inch
SLIDE LENGTH	207 mm	8.15 inch	174 mm	6.85 inch	174 mm	6.85 inch
BARREL LENGTH	135 mm	5.31 inch	102 mm	4.02 inch	102 mm	4.02 inch
WIDTH (OVERALL)	34 mm	1.34 inch	33 mm	1.30 inch	34 mm	1.34 inch
SLIDE WIDTH	25,5 mm	1.00 inch	25,5 mm	1.00 inch	25,5 mm	1.00 inch
HEIGHT INCL. MAGAZINE	139 mm	5.47 inch	139 mm	5.47 inch	139 mm	5.47 inch
WEIGHT w/o MAGAZINE	665 g	23.46 oz	625 g	22.05 oz	616 g	21.73 oz
WEIGHT w. empty MAGAZINE	743 g	26.21 oz	704 g	24.83 oz	694 g	24.48 oz
**WEIGHT w. loaded MAGAZINE	980 g	34.57 oz	890 g	31.39 oz	860 g	30.34 oz
*TRIGGER DISTANCE	70 mm	2.76 inch	70 mm	2.76 inch	70 mm	2.76 inch
TRIGGER PULL (~)	24 N		26 N		26 N	
SIGHT RADIUS POLYMER	191 mm	7.52 inch	153 mm	6.02 inch	153 mm	6.02 inch
SIGHT RADIUS STEEL	190 mm	7.48 inch	152 mm	5.98 inch	152 mm	5.98 inch
SIGHT RADIUS GNS	189 mm	7.44 inch	151 mm	5.94 inch	151 mm	5.94 inch
MAGAZINE CAPACITY	17		17		17	

*For Gen4/Gen5 Models: Dimensions for medium backstrap w/o beavertail (+2 mm | 0.08 in.) and for large backstrap w/o beavertail (+4 mm | 0.16 in.)

** Depending on ammunition. + Technical data also applicable for MOS configuration.

Technical data are rounded and do not reflect tolerances – they may be altered without notice.

Technical data of the different generations **GEN5** **GEN4** **PREVIOUS** and technical configurations of the same model are mostly similar.

TECHNICAL DATA	G43		G43 X		G48	
SYSTEM	SAFE ACTION® (constant double action mode), all GLOCK pistols come with 3 safeties					
CALIBER	9 mm Luger					
*LENGTH (OVERALL)	159 mm	6.26 inch	165 mm	6.50 inch	185 mm	7.28 inch
SLIDE LENGTH	154 mm	6.06 inch	154 mm	6.06 inch	174 mm	6.85 inch
BARREL LENGTH	86,5 mm	3.41 inch	87 mm	3.41 inch	106 mm	4.17 inch
WIDTH (OVERALL)	27 mm	1.06 inch	28 mm	1.10 inch	28 mm	1.10 inch
SLIDE WIDTH	22 mm	0.87 inch	22 mm	0.87 inch	22 mm	0.87 inch
HEIGHT INCL. MAGAZINE	108 mm	4.25 inch	128 mm	5.04 inch	128 mm	5.04 inch
WEIGHT w/o MAGAZINE	460 g	16.23 oz	465 g	16.40 oz	524 g	18.48 oz
WEIGHT w. empty MAGAZINE	510 g	17.99 oz	530 g	18.70 oz	588 g	20.74 oz
**WEIGHT w. loaded MAGAZINE	585 g	20.64 oz	654 g	23.07 oz	712 g	25.12 oz
*TRIGGER DISTANCE	65 mm	2.56 inch	67 mm	2.64 inch	67 mm	2.64 inch
TRIGGER PULL (~)	24 N		24 N		24 N	
SIGHT RADIUS POLYMER	133 mm	5.24 inch	133 mm	5.24 inch	152 mm	5.98 inch
SIGHT RADIUS STEEL	132 mm	5.20 inch	132 mm	5.20 inch	151 mm	5.94 inch
SIGHT RADIUS GNS	131 mm	5.16 inch	131 mm	5.16 inch	150 mm	5.91 inch
MAGAZINE CAPACITY	6		10		10	

*For Gen4/Gen5 Models: Dimensions for medium backstrap w/o beavertail (+2 mm | 0.08 in.) and for large backstrap w/o beavertail (+4 mm | 0.16 in.)

** Depending on ammunition. + Technical data also applicable for MOS configuration.

Technical data are rounded and do not reflect tolerances – they may be altered without notice.



40 S&W

Safe Action® Pistols

GLOCK 22 Gen4

The 40 S&W caliber closes the gap between the heavy 45 Auto calibers and the 9 mm Luger service calibers. GLOCK was the first manufacturer to make the advantages of this balanced caliber accessible to law enforcement agencies. By applying the Gen4 technology with the Modular back strap design and the reversible magazine catch to this pistol model the user may instantly customize its grip.



Also available as: GLOCK 22

- 15
- STANDARD
- GEN4**
- PREVIOUS



40 S&W

Increased release of energy in the target, optimised urban applicability.

GLOCK 23 Gen4

GLOCK's compact 40 S&W, equivalent of the GLOCK 19 Gen4, puts controllable power into an ideally-sized package – substantial enough for police patrol, small enough for discreet and comfortable all-day concealed carry. It is the top choice for professionals who work undercover. The Modular back strap system makes it possible to instantly customize its grip to accommodate any hand size. The reversible magazine catch makes it ideal for left and right-handed shooters.



Also available as: GLOCK 23

- 13
- COMPACT
- GEN4**
- PREVIOUS

GLOCK 24

The long slide and barrel design combined with the 40 S&W caliber cartridge make this GLOCK a great choice for a multitude of shooting activities.



- 15
- LONG SLIDE
- PREVIOUS**

GLOCK 27 Gen4

The GLOCK 27 Gen4, in 40 S&W, introduces innovative design changes to this small, light, accurate and powerful pistol that so many U.S. law enforcement agencies have chosen as their official backup weapon. The Modular back strap design and the reversible magazine catch make it possible to instantly customize its grip to accommodate any hand size. The surface of the frame employs the new Gen4 rough textured technology. A reversible enlarged magazine catch, easily changeable accommodates left and right-handed operators.

Also available as: GLOCK 27



🔫 9
SUBCOMPACT
GEN4
PREVIOUS

GLOCK 35 Gen4 MOS

The GLOCK 35 Gen4 in MOS configuration combines an extended barrel, longer slide dimensions and elongated distance between the sights with the MOS concept, making it easy to mount a reflex sight on the pistol's slide without the need for a new slide or separate mounting system. The Modular back strap system makes it possible to instantly customize its grip to accommodate any hand size. The reversible magazine catch makes it ideal for left and right-handed shooters.

Also available as: GLOCK 35 Gen4, GLOCK 35



Optic not included!

🔫 15
COMPETITION
GEN4
MOS
PREVIOUS

TECHNICAL DATA	G22 GEN4		G23 GEN4		G24		G27 GEN4		G35 GEN4+	
SYSTEM	SAFE ACTION® (constant double action mode), all GLOCK pistols come with 3 safeties									
CALIBER	40 S&W									
*LENGTH (OVERALL)	202 mm	7.95 inch	185 mm	7.28 inch	243 mm	9.57 inch	163 mm	6.42 inch	222 mm	8.74 inch
SLIDE LENGTH	186 mm	7.32 inch	174 mm	6.85 inch	225 mm	8.86 inch	159 mm	6.26 inch	207 mm	8.15 inch
BARREL LENGTH	114 mm	4.49 inch	102 mm	4.02 inch	153 mm	6.02 inch	87 mm	3.43 inch	135 mm	5.31 inch
WIDTH (OVERALL)	32 mm	1.26 inch	32 mm	1.26 inch	33 mm	1.30 inch	32 mm	1.26 inch	33 mm	1.30 inch
SLIDE WIDTH	25,5 mm	1.00 inch	25,5 mm	1.00 inch	25,5 mm	1.00 inch	25,5 mm	1.00 inch	25,5 mm	1.00 inch
HEIGHT INCL. MAGAZINE	139 mm	5.47 inch	128 mm	5.04 inch	139 mm	5.47 inch	106 mm	4.17 inch	139 mm	5.47 inch
WEIGHT w/o MAGAZINE	645 g	22.75 oz	605 g	21.34 oz	760 g	26.81 oz	550 g	19.40 oz	705 g	24.87 oz
WEIGHT w. empty MAGAZINE	725 g	25.57 oz	675 g	23.81 oz	840 g	29.63 oz	605 g	21.34 oz	785 g	27.69 oz
**WEIGHT w. loaded MAGAZINE	975 g	34.39 oz	890 g	31.39 oz	1090 g	38.45 oz	750 g	26.46 oz	1035 g	36.51 oz
*TRIGGER DISTANCE	70 mm	2.76 inch	70 mm	2.76 inch	71,5 mm	2.81 inch	70 mm	2.76 inch	70 mm	2.76 inch
TRIGGER PULL (~)	28 N		28 N		28 N		28 N		24 N	
SIGHT RADIUS POLYMER	165 mm	6.50 inch	153 mm	6.02 inch	205 mm	8.07 inch	137 mm	5.39 inch	192 mm	7.56 inch
SIGHT RADIUS STEEL	164 mm	6.46 inch	152 mm	5.98 inch	204 mm	8.03 inch	136 mm	5.35 inch	191 mm	7.52 inch
SIGHT RADIUS GNS	163 mm	6.42 inch	151 mm	5.94 inch	203 mm	7.99 inch	135 mm	5.31 inch	190 mm	7.48 inch
MAGAZINE CAPACITY	15		13		15		9		15	

*For Gen4/Gen5 Models: Dimensions for medium backstrap w/o beavertail (+2 mm | 0.08 in.) and for large backstrap w/o beavertail (+4 mm | 0.16 in.)

** Depending on ammunition. + Technical data also applicable for MOS configuration.

Technical data are rounded and do not reflect tolerances – they may be altered without notice.

Technical data of the different generations **GEN4** **PREVIOUS** and technical configurations of the same model are mostly similar.



MOS

MODULAR OPTIC SYSTEM CONFIGURATION

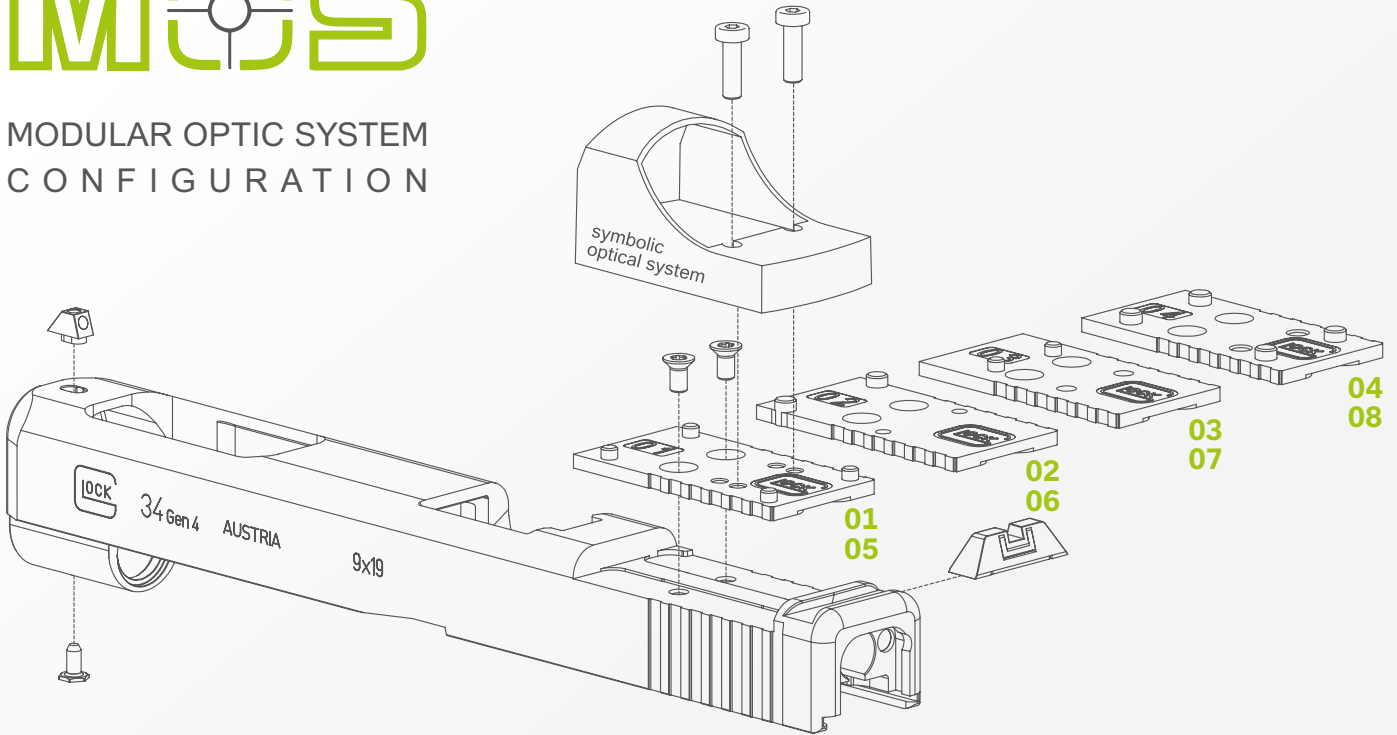

GLOCK engineers have developed the Modular Optic System pistol configuration to simplify mounting of popular optical sights. The MOS configuration is the ideal choice to hit your target.

There are numbered GLOCK MOS adapter plates available for optical sights of following manufacturers:

- Adapter Docter, Meopta, Insight **(01/05)***
- Adapter Trijicon **(02/06)***
- Adapter C-More **(03/07)***
- Adapter Leupold **(04/08)***

*depending on slide width

The MOS adapter-sets include a Torx® screwdriver (TX10) and 4 Torx® screws to install the GLOCK MOS adapter plates. All screws come with a drop of glue applied.



+ MOS configuration is available for following pistol models:



G17 Gen5 MOS
Also available as:
G17 Gen4 MOS



G19 Gen5 MOS
Also available as:
G19 Gen4 MOS



G34 Gen5 MOS
Also available as:
G34 Gen4 MOS



G35 Gen4 MOS



G40 Gen4 MOS



G41 Gen4 MOS



G45 MOS

Optic not included!





380 Auto

Safe Action® Pistols

GLOCK 25

Because of its small dimensions, equal to those of the GLOCK 19, the GLOCK 25 in the low-recoil .380 caliber can be comfortably carried concealed.



 15 COMPACT **PREVIOUS**

GLOCK 28

Small in size and weight the GLOCK 28 excels in performance while measuring small enough for a pocket or ankle holster. Because of the low-recoil firing characteristics of the .380 cartridge, it can be easily and accurately controlled.



 10 SUBCOMPACT **PREVIOUS**



380 AUTO

Particularly easy controllability with convincing ballistics and a 9 mm projectile.





GLOCK 42

6 SUBCOMPACT SLIM SLIM



For those discerning shooters who desired the smallest GLOCK possible, the company responded with the now popular G42 in 380 Auto with ultra-compact dimensions and easy-to-shoot characteristics. The G42 packs all the features GLOCK customers have come to appreciate – from the GLOCK Safe Action® system with its multiple integrated safety features to the brand’s proven reliability and durability.

TECHNICAL DATA	G25		G28		G42	
SYSTEM	SAFE ACTION® (constant double action mode), all GLOCK pistols come with 3 safeties					
CALIBER	380 Auto					
*LENGTH (OVERALL)	187 mm	7.36 inch	165 mm	6.50 inch	151 mm	5.94 inch
SLIDE LENGTH	174 mm	6.85 inch	159 mm	6.26 inch	146 mm	5.75 inch
BARREL LENGTH	102 mm	4.02 inch	87 mm	3.43 inch	82,5 mm	3.25 inch
WIDTH (OVERALL)	32 mm	1.26 inch	32 mm	1.26 inch	25 mm	0.98 inch
SLIDE WIDTH	25,5 mm	1.00 inch	25,5 mm	1.00 inch	21 mm	0.83 inch
HEIGHT INCL. MAGAZINE	128 mm	5.04 inch	106 mm	4.17 inch	105 mm	4.13 inch
WEIGHT w/o MAGAZINE	575 g	20.28 oz	530 g	18.70 oz	345 g	12.17 oz
WEIGHT w. empty MAGAZINE	645 g	22.75 oz	585 g	20.64 oz	390 g	13.76 oz
**WEIGHT w. loaded MAGAZINE	785 g	27.69 oz	685 g	24.16 oz	450 g	15.87 oz
*TRIGGER DISTANCE	71,2 mm	2.80 inch	72 mm	2.83 inch	61 mm	2.40 inch
TRIGGER PULL (~)	28 N		28 N		24 N	
SIGHT RADIUS POLYMER	153 mm	6.02 inch	137 mm	5.39 inch	125 mm	4.92 inch
SIGHT RADIUS STEEL	152 mm	5.98 inch	136 mm	5.35 inch	124 mm	4.88 inch
SIGHT RADIUS GNS	151 mm	5.94 inch	135 mm	5.31 inch	123 mm	4.84 inch
MAGAZINE CAPACITY	15		10		6	

*For Gen4/Gen5 Models: Dimensions for medium backstrap w/o beavertail (+2 mm | 0.08 in.) and for large backstrap w/o beavertail (+4 mm | 0.16 in.)
 ** Depending on ammunition. + Technical data also applicable for MOS configuration.
 Technical data are rounded and do not reflect tolerances – they may be altered without notice.



Slimline

Concealed Carry

SLIMLINE



SLIM FRAME & REVERSIBLE MAGAZINE CATCH

BUILT-IN BEAVERTAIL DESIGN & SHORT TRIGGER DISTANCE

GLOCK SINGLE STACK MAGAZINE (G42, G43)
GLOCK SLIM .01 MAGAZINE (G43X, G48)



COMFORTABLE
Built-in Beavertail Design

SIZE MATTERS
GLOCK single stack magazine

The smallest GLOCK pistol ever – developed for concealed carry!

Designed to be the favored back up; perfect for everyday concealed carry needs. Slim construction – par excellence: slim slide and slim frame with a single stack magazine.

SLIM
LINE 

DIVERSITY

Silver colored nPVD coating for G43X & G48 Silver slide

USER FRIENDLY

Reversible magazine catch



10 mm Auto

Safe Action® Pistols



10 mm AUTO

Maximum ballistic performance and maximum penetrative power, the ultimate force.

GLOCK 20 Gen4

The GLOCK 20 Gen4 delivers formidable force downrange with high accuracy over long distance. The use of GLOCK hi-tech polymer considerably reduces felt recoil even in this heavy caliber. For the hunting community this 10 mm Auto is a reliable companion providing a safe and accurate finishing shot, even when hunting big game. The Modular back strap system makes it possible to instantly customize its grip to accommodate any hand size. The reversible magazine catch makes it ideal for left and right-handed shooters.

Also available as: GLOCK 20 SF



- 15
- STANDARD
- GEN4**
- SF

GLOCK 29 Gen4

The GLOCK 29 Gen4 offers the concealment of a compact pistol while delivering the raw, long-range power of the 'magnum force' 10 mm Auto cartridge with ease. The Gen4 design offers an aggressive grip pattern to allow for a more secure grip on the pistol, even with gloved hands.

Also available as: GLOCK 29 SF

🔫 10
SUBCOMPACT
GEN4
SF



GLOCK 40 Gen4 MOS

The G40 Gen4 in MOS Configuration is chambered in 10 mm Auto and combines a long slide and barrel for improved velocity with a high magazine capacity. The Modular Back Strap design and the reversible magazine catch let you instantly customize its grip to adapt to accommodate any hand size. The MOS Configuration makes an easy job of mounting a reflex sight on the pistol's slide without the need for a new slide or separate mounting system.

Only available as GLOCK 40 Gen4 in MOS Configuration

🔫 15
LONGSLIDE
GEN4
MOS



Optic not included!

TECHNICAL DATA	G20 GEN4		G29 GEN4		G40 GEN4*	
SYSTEM	SAFE ACTION® (constant double action mode), all GLOCK pistols come with 3 safeties					
CALIBER	10 mm Auto					
*LENGTH (OVERALL)	205 mm	8.07 inch	177 mm	6.97 inch	241 mm	9.49 inch
SLIDE LENGTH	193 mm	7.60 inch	172 mm	6.77 inch	229 mm	9.02 inch
BARREL LENGTH	117 mm	4.61 inch	96 mm	3.78 inch	153 mm	6.02 inch
WIDTH (OVERALL)	34 mm	1.34 inch	35 mm	1.38 inch	34 mm	1.34 inch
SLIDE WIDTH	28,5 mm	1.12 inch	28,5 mm	1.12 inch	28,5 mm	1.12 inch
HEIGHT INCL. MAGAZINE	140 mm	5.51 inch	115 mm	4.53 inch	139 mm	5.47 inch
WEIGHT w/o MAGAZINE	780 g	27.51 oz	690 g	24.34 oz	915 g	32.28 oz
WEIGHT w. empty MAGAZINE	870 g	30.69 oz	760 g	26.81 oz	1005 g	35.45 oz
**WEIGHT w. loaded MAGAZINE	1130 g	39.86 oz	925 g	32.63 oz	1265 g	44.62 oz
*TRIGGER DISTANCE	72,5 mm	2.85 inch	72,5 mm	2.85 inch	72,5 mm	2.85 inch
TRIGGER PULL (~)	28 N		28 N		24 N	
SIGHT RADIUS POLYMER	172 mm	6.77 inch	150 mm	5.91 inch	211 mm	8.31 inch
SIGHT RADIUS STEEL	171 mm	6.73 inch	149 mm	5.87 inch	210 mm	8.27 inch
SIGHT RADIUS GNS	170 mm	6.69 inch	148 mm	5.83 inch	209 mm	8.23 inch
MAGAZINE CAPACITY	15		10		15	

*For Gen4/Gen5 Models: Dimensions for medium backstrap w/o beavertail (+2 mm | 0.08 in.) and for large backstrap w/o beavertail (+4 mm | 0.16 in.)

** Depending on ammunition. + Technical data also applicable for MOS configuration.

Technical data are rounded and do not reflect tolerances – they may be altered without notice.

Technical data apply of the different generations **GEN4** **PREVIOUS** and technical configurations **SF** of the same model are mostly similar.



45 Auto

Safe Action® Pistols

GLOCK 21 Gen4

Remarkable for its accuracy and light recoil, the GLOCK 21 Gen4 delivers the power of the 45 Auto round with high magazine capacity. The Modular Back Strap system makes it possible to instantly customize its grip to accommodate any hand size. The reversible magazine catch makes it ideal for left and right-handed shooters. The Gen4 system is the perfect complement to the 45 Auto caliber cartridge.

Also available as: G21 SF



13	STANDARD	GEN4	SF
----	----------	-------------	-----------

GLOCK 30 Gen4

The GLOCK 30 Gen4 in the 45 Auto offers excellent out-of-the-box precision paired with the ballistic quality of this caliber. The Gen4 design of this small easy-to-shoot package combines a shorter trigger reach with a great magazine capacity.

Also available as: GLOCK 30 SF, GLOCK 30 S



10	SUBCOMPACT	GEN4	SF	S
----	------------	-------------	-----------	----------



GLOCK 36

6	SUBCOMPACT SLIM	SLIM
---	-----------------	-------------

Six rounds of 45 Auto in a package that fits into the hands of any user. The GLOCK 36 presents grip ergonomics of the next dimension. The GLOCK single stack magazine allows for a slim frame and a slide with reduced width. Together with the secure-grip design and minimal trigger-to-grip distance this makes handling the pistol very simple.

SLIM

SLIM FRAME

GLOCK SINGLE STACK MAGAZINE

GLOCK 41 Gen4 MOS

The GLOCK 41 Gen4 is a 45 Auto caliber pistol designed to maximize sight radius while achieving perfect weight distribution and balance. The longer barrel and slide help to reduce muzzle flip and felt recoil whereas the MOS Configuration makes it easy to mount a miniature reflex sight on the pistol's slide without the need for a new slide or separate mounting system. The Modular Back Strap system makes it possible to instantly customize its grip to accommodate any hand size. The reversible magazine catch makes it ideal for left and right-handed shooters.

Also available as: GLOCK 41 Gen4



Optic not included!

13
COMPETITION
GEN4
MOS



45 AUTO

Over 100 years and this caliber still offers outstanding precision and maximum release of energy.

TECHNICAL DATA	G21 GEN4		G30 GEN4		G36		G41 GEN4+	
SYSTEM	SAFE ACTION® (constant double action mode), all GLOCK pistols come with 3 safeties							
CALIBER	45 Auto							
*LENGTH (OVERALL)	205 mm	8.07 inch	177 mm	6.97 inch	177 mm	6.97 inch	223 mm	8.78 inch
SLIDE LENGTH	193 mm	7.60 inch	172 mm	6.77 inch	172 mm	6.77 inch	211 mm	8.31 inch
BARREL LENGTH	117 mm	4.61 inch	96 mm	3.78 inch	96 mm	3.78 inch	135 mm	5.31 inch
WIDTH (OVERALL)	34 mm	1.34 inch	35 mm	1.38 inch	30 mm	1.18 inch	34 mm	1.34 inch
SLIDE WIDTH	28,5 mm	1.12 inch	28,5 mm	1.12 inch	25,5 mm	1.00 inch	25,5 mm	1.00 inch
HEIGHT INCL. MAGAZINE	140 mm	5.51 inch	122 mm	4.80 inch	120 mm	4.72 inch	139 mm	5.47 inch
WEIGHT w/o MAGAZINE	745 g	26.28 oz	675 g	23.81 oz	565 g	19.93 oz	675 g	23.81 oz
WEIGHT w. empty MAGAZINE	830 g	29.28 oz	745 g	26.28 oz	635 g	22.40 oz	760 g	26.81 oz
**WEIGHT w. loaded MAGAZINE	1100 g	38.80 oz	955 g	33.69 oz	760 g	26.81 oz	1035 g	36.51 oz
*TRIGGER DISTANCE	72,5 mm	2.85 inch	72,5 mm	2.85 inch	75 mm	2.95 inch	72,5 mm	2.85 inch
TRIGGER PULL (~)	28 N		28 N		28 N		24 N	
SIGHT RADIUS POLYMER	172 mm	6.77 inch	150 mm	5.91 inch	150 mm	5.91 inch	195 mm	7.68 inch
SIGHT RADIUS STEEL	171 mm	6.73 inch	149 mm	5.87 inch	149 mm	5.87 inch	194 mm	7.64 inch
SIGHT RADIUS GNS	170 mm	6.69 inch	148 mm	5.83 inch	148 mm	5.83 inch	193 mm	7.60 inch
MAGAZINE CAPACITY	13		10		6		13	

*For Gen4/Gen5 Models: Dimensions for medium backstrap w/o beavertail (+2 mm | 0.08 in.) and for large backstrap w/o beavertail (+4 mm | 0.16 in.)

** Depending on ammunition. + Technical data also applicable for MOS configuration.

Technical data are rounded and do not reflect tolerances – they may be altered without notice.

Technical data of the different generations [GEN4](#) [PREVIOUS](#) and technical configurations [SF](#) [S](#) of the same model are mostly similar.



357 SIG

Safe Action® Pistols

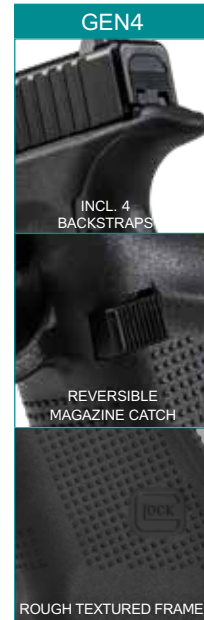

GLOCK 31 Gen4

🔫 15 STANDARD **GEN4** PREVIOUS

The GLOCK 31 Gen4, in 357 SIG, is the optimal solution for those seeking high muzzle velocity and superior precision in a reliable, yet lightweight, pistol with large magazine capacity. The Modular back strap system makes it possible to instantly customize its grip to accommodate any hand size. The reversible magazine catch makes it ideal for left and right-handed shooters.

Also available as: GLOCK 31

GLOCK 32 Gen4

Designed as a compact model, the GLOCK 32 Gen4, in 357 SIG, offers a unique combination of versatility, convincing ballistics, optimum carry comfort, and the legendary GLOCK pistol reliability. The Modular back strap design and the reversible magazine catch let you instantly customize its grip to adapt to an individual shooter.



Also available as: GLOCK 32

🔫 13 COMPACT **GEN4** PREVIOUS

GLOCK 33 Gen4

The GLOCK 33 Gen4 offers convincing concealment capabilities, but with the formidable performance of the 357 SIG round. Meet the accurate, powerful and snappy G33 Gen4 with its ergonomic external controls and grip options.



Also available as: GLOCK 33

🔫 9 SUBCOMPACT **GEN4** PREVIOUS

TECHNICAL DATA	G31 GEN4		G32 GEN4		G33 GEN4	
SYSTEM	SAFE ACTION® (constant double action mode), all GLOCK pistols come with 3 safeties					
CALIBER	357 SIG					
*LENGTH (OVERALL)	202 mm	7.95 inch	185 mm	7.28 inch	163 mm	6.42 inch
SLIDE LENGTH	186 mm	7.32 inch	174 mm	6.85 inch	159 mm	6.26 inch
BARREL LENGTH	114 mm	4.49 inch	102 mm	4.02 inch	87 mm	3.43 inch
WIDTH (OVERALL)	32 mm	1.26 inch	32 mm	1.26 inch	32 mm	1.26 inch
SLIDE WIDTH	25,5 mm	1.00 inch	25,5 mm	1.00 inch	25,5 mm	1.00 inch
HEIGHT INCL. MAGAZINE	139 mm	5.47 inch	128 mm	5.04 inch	107 mm	4.21 inch
WEIGHT w/o MAGAZINE	660 g	23.28 oz	620 g	21.87 oz	560 g	19.75 oz
WEIGHT w. empty MAGAZINE	740 g	26.10 oz	690 g	24.34 oz	620 g	21.87 inch
**WEIGHT w. loaded MAGAZINE	940 g	33.16 oz	860 g	30.34 oz	735 g	25.93 inch
*TRIGGER DISTANCE	70 mm	2.76 inch	70 mm	2.76 inch	70 mm	2.76 inch
TRIGGER PULL (~)	28 N		28 N		28 N	
SIGHT RADIUS POLYMER	165 mm	6.50 inch	153 mm	6.02 inch	137 mm	5.39 inch
SIGHT RADIUS STEEL	164 mm	6.46 inch	152 mm	5.98 inch	136 mm	5.35 inch
SIGHT RADIUS GNS	163 mm	6.42 inch	151 mm	5.94 inch	135 mm	5.31 inch
MAGAZINE CAPACITY	15		13		9	

*For Gen4/Gen5 Models: Dimensions for medium backstrap w/o beavertail (+2 mm | 0.08 in.) and for large backstrap w/o beavertail (+4 mm | 0.16 in.)

** Depending on ammunition. + Technical data also applicable for MOS configuration.

Technical data are rounded and do not reflect tolerances – they may be altered without notice.

Technical data of the different generations **GEN4** **PREVIOUS** and technical configurations of the same model are mostly similar.



357 SIG

Maximum velocity and penetrative power – even against light armour.



GLOCK Previous Generation

Safe Action® Pistols

THE INITIAL CONCEPT

Reliable Safe Action® System, combined with hardened steel slide and barrel. Innovative safety features and outstanding reliability.

Polymer frame for weight reduction and high magazine capacity – few parts, low maintenance.



RESISTANT

Surface refinement for all GLOCK metal parts

ACCESSORIES

Mounting rail for tactical lights and lasers



PREVIOUS

RELIABILITY

GLOCK's Safe Action[®] System

DURABLE

Polymer frame with enhanced grip traction



45 GAP

Safe Action® Pistols

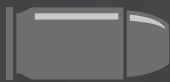

45 GAP

All the power of a 45 Auto in a casing of reduced size.

GLOCK 37

For those who prefer large-caliber handguns, the GLOCK 37, in 45 GAP, represents a quantum leap in big-bore technology. This all-round pistol delivers power-packed performance in a standard-framed handgun.



-  10
- STANDARD
- PREVIOUS**



GLOCK 38

The GLOCK 38 is a compact sized 45 GAP offering carrying comfort and excellent performance in accuracy and power.

8
COMPACT
PREVIOUS



GLOCK 39

Built around the design parameters of GLOCK's subcompact models, the GLOCK 39 mixes small, concealable size with the power and accuracy of the 45 GAP cartridge.

6
SUBCOMPACT
PREVIOUS

TECHNICAL DATA	G37		G38		G39	
SYSTEM	SAFE ACTION® (constant double action mode), all GLOCK pistols come with 3 safeties					
CALIBER	45 GAP					
*LENGTH (OVERALL)	204 mm	8.03 inch	187 mm	7.36 inch	165 mm	6.50 inch
SLIDE LENGTH	186 mm	7.32 inch	174 mm	6.85 inch	159 mm	6.26 inch
BARREL LENGTH	114 mm	4.49 inch	102 mm	4.02 inch	87 mm	3.43 inch
WIDTH (OVERALL)	33 mm	1.30 inch	33 mm	1.30 inch	33 mm	1.30 inch
SLIDE WIDTH	28,5 mm	1.12 inch	28,5 mm	1.12 inch	28,5 mm	1.12 inch
HEIGHT INCL. MAGAZINE	139 mm	5.47 inch	128 mm	5.04 inch	106 mm	4.17 inch
WEIGHT w/o MAGAZINE	740 g	26.10 oz	685 g	24.16 oz	630 g	22.22 oz
WEIGHT w. empty MAGAZINE	815 g	28.75 oz	755 g	26.63 oz	685 g	24.16 oz
**WEIGHT w. loaded MAGAZINE	1000 g	35.27 oz	900 g	31.75 oz	790 g	27.87 oz
*TRIGGER DISTANCE	72 mm	2.83 inch	71,2 mm	2.80 inch	72 mm	2.83 inch
TRIGGER PULL (~)	28 N		28 N		28 N	
SIGHT RADIUS POLYMER	165 mm	6.50 inch	153 mm	6.02 inch	137 mm	5.39 inch
SIGHT RADIUS STEEL	164 mm	6.46 inch	152 mm	5.98 inch	136 mm	5.35 inch
SIGHT RADIUS GNS	163 mm	6.42 inch	151 mm	5.94 inch	135 mm	5.31 inch
MAGAZINE CAPACITY	10		8		6	

*For Gen4/Gen5 Models: Dimensions for medium backstrap w/o beavertail (+2 mm | 0.08 in.) and for large backstrap w/o beavertail (+4 mm | 0.16 in.)

** Depending on ammunition. + Technical data also applicable for MOS configuration.

Technical data are rounded and do not reflect tolerances – they may be altered without notice.



Compensated Pistols

Safe Action® Pistols



REDUCED RECOIL AND INCREASED PRECISION

The compensated GLOCK pistol models are equipped with an integrated compensator to improve hit patterns during rapid firing.

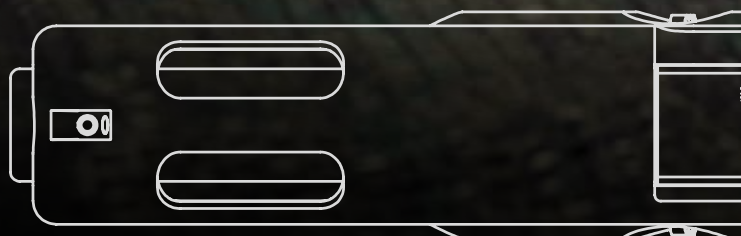



GLOCK Compensated models

The barrel of a compensated pistol model has two small, elongated ports that straddle the centerline and exhaust through two vents cut into the top of the slide. This parallel port compensation system reduces muzzle flip and felt recoil and aids in quicker second shot target acquisition. The compensated barrel assists to getting back on target quicker for the critical follow-up shot. From the first shot to the last, the shooter gets improved shooting speed and minimum muzzle rise with little or no loss of velocity.

Available models:



G17 C Gen4



G19 C Gen4



G21 C Gen4



G31 C Gen4



Cutaway Models

Safe Action® Pistols

GLOCK Cutaway models

GLOCK cutaway models are specially produced for technical firearms training. The GLOCK cutaway is always an attraction during training classes, presentations and trade fairs since it clearly illustrates the ingeniously simple interaction of the internal safeties of the GLOCK Safe Action® System.



Available models:



G17 Gen5 Cutaway
Also available as:
G17 Gen4 Cutaway



G19 Gen5 Cutaway
Also available as:
G19 Gen4 Cutaway



G22 Cutaway



G23 Cutaway



G26 Cutaway



GLOCK Training pistols

Taking training to the next level requires more than just paper targets and an hour at the range. With situations and engagements becoming more complex, modern law enforcement and military units use Force-on-Force training to give their officers and soldiers the training they need to succeed.

The GLOCK Training pistols were developed for the purpose of enabling reality-based tactical operations' training with colour marking or plastic bullet ammunition.

GLOCK offers a wide range of Training tools to help customers prepare for the real world while maintaining the same handling and ergonomics as the regular GLOCK pistols.



Available models:



G17T Gen5 FX/FOF

Also available as:
G17T Gen4 FX/FOF
G17T FX/FOF



G17T UTM



G19T Gen5 FX/FOF

Also available as:
G19T Gen4 FX/FOF
G19T FX/FOF



G19T UTM



GLOCK Practice & Reset pistols

Proper grip, loading, unloading, sight alignment, trigger squeeze and disassembling are all part of a shooter's training routine. The GLOCK Practice Pistol was developed to eliminate dangerous scenarios during training exercises. Identical to a GLOCK pistol in handling, weight, size and balance, it puts the real thing in your hand, without any firing capability.

Expanding the range of GLOCK dry-fire pistols is the Reset pistol. The GLOCK R models were created with shooting simulators in mind. An aftermarket laser impulse generator can be integrated into the barrel, which will fire a laser impulse with every pull of the trigger. Unlike the Practice pistol, the reset pistols trigger will automatically reset after every shot, making racking the slide obsolete during training.

Available models:



G17P Gen5
Also available as:
G45P



G22P
Also available as:
G17P



G23P



GLOCK Magazine Capacity

For G44 related information refer to pages 12-15.

Standard
 Optional
 - Extended floor plate (+1 round)
 = Extended floor plate (+2 rounds)

For information on compatibility within caliber groups and models please check with your local dealer or on www.glock.com.

Magazine Capacity		31+2	24	22	17+2	17	15+2	15+1	15	13+1	13	10+2	10	9+1	9	8	6
9 mm Luger	GLOCK 17																
	GLOCK 19X																
	GLOCK 19																
	GLOCK 26																
	GLOCK 34																
	GLOCK 17L																
	GLOCK 43																
	GLOCK 43X																
	GLOCK 45																
	GLOCK 48																
40 S&W	GLOCK 22																
	GLOCK 23																
	GLOCK 24																
	GLOCK 27																
	GLOCK 35																
380 Auto	GLOCK 25																
	GLOCK 28																
	GLOCK 42																
10 mm Auto	GLOCK 20																
	GLOCK 29																
	GLOCK 40																
45 Auto	GLOCK 21																
	GLOCK 30																
	GLOCK 36																
	GLOCK 41																
357 SIG	GLOCK 31																
	GLOCK 32																
	GLOCK 33																
45 GAP	GLOCK 37																
	GLOCK 38																
	GLOCK 39																

GLOCK Magazines

Like no other pistol, GLOCK pistols permit a high level of compatibility of the magazines within a caliber. Except for the slimline and slim models, standard magazines, can also be used for backup weapons of the same caliber. Compact and subcompact GLOCK pistol model magazines can be loaded with a compelling number of rounds.

The innovative polymer frame of the GLOCK pistol does not require grip shells. As a result, it has considerably more space for the magazine body and enables double-row staggered cartridge configuration. For this reason, GLOCK pistols are superior in firepower to conventional pistol models of the same size. GLOCK magazines have a stiff metal tube encased in the proven GLOCK high-tech polymer. This resists deformation – even when dropped from great height or exposed to extreme environments.

To reflect user's requirements for higher reloading speed and better visibility GLOCK also offers magazines featuring an orange follower and a floor plate which is enlarged at the front.

Magazines with extended floor plates (for higher magazine capacity) are available in calibers 9 mm Luger, 40 S&W, 380 Auto and 357 SIG.

The GLOCK single stack magazines comply with the reduced dimensions of the subcompact slim and slimline models, a magazine extension for better grip is also available.

The GLOCK Slim 01 magazines only fit for the G43X and G48.



Learn more about the **compact G44 in 22 l.r.** on pages 12-15.





GLOCK Compatibility

The GLOCK Safe Action® pistol is manufactured with only 35 component parts, a significantly lower number of parts than the semi-automatic pistol designs of GLOCK's competitors. This smaller number of component parts increases reliability by reducing the potential for technical problems. The cost associated with spare parts inventory is reduced, which contributes to the lower overall maintenance costs for the life of the GLOCK pistol.



Customize your GLOCK!

For G44 related information refer to pages 12-15.

Modify your GLOCK pistol to meet your individual requirements by changing the sights, slide stop lever, magazine catch, trigger pull or by switching to a threaded barrel.

For compatibility and more details visit www.glock.com

1. FRONT SIGHT				
 POLYMER	 STEEL	 STEEL LUMINESCENT	 STEEL NIGHT SIGHT	
2. REAR SIGHT				
 POLYMER	 STEEL SIGHT	 STEEL LUMINESCENT	 STEEL NIGHT SIGHT	 ADJUSTABLE POLYMER
3. SLIDE STOP LEVER				
 GEN4 PREVIOUS SLIDE STOP LEVER STANDARD	 GEN4 PREVIOUS SLIDE STOP LEVER EXTENDED	 GEN5 AMBIDEXTROUS SLIDE STOP LEVER STANDARD	 GEN5 AMBIDEXTROUS SLIDE STOP LEVER EXTENDED	 SLIM SLIDE STOP LEVER STANDARD
4. MAGAZINE CATCH				
 PREVIOUS STANDARD	 PREVIOUS EXTENDED	 GEN4 GEN5 STANDARD REVERSIBLE	 GEN4 GEN5 EXTENDED REVERSIBLE	 SLIM STANDARD REVERSIBLE
5. TRIGGER PULL		6. THREADED BARREL		
 CONNECTORS	 PREVIOUS TRIGGER SPRINGS	 M13x1 LEFT FOR 9 mm LUGER	 M16x1 LEFT FOR 45 AUTO	 M12x0.75 RIGHT FOR .380

Symbolic pictures



Options

Safe Action® Pistols



OD green

GLOCK offers several pistol models of the Previous generation with an OD green color frame. Check with your local dealer for more information on models and availability.



Colored frames

GLOCK does limited runs for Gen4 pistol models with colored frames. For information about limited runs please check with your local dealer on models and availability.



Front serrations

The front serrations (FS) provide an additional tactile surface choice when manipulating the slide giving the operator positive traction even with wet or sweaty hands. This new design offers the advantage for professional users to do a fast press check before and after firing. The user may grip the slide by the front serrations with the weak hand and move it to the rear until a clear view of the chamber is possible in order to ensure that a round is properly chambered. When done correctly the hand gets nowhere near the muzzle of the pistol.

For available models please check with your local GLOCK dealer or on www.glock.com.



GLOCK Safety lock*

LOCK YOUR GLOCK PISTOL WITH A CYLINDER LOCK

The GLOCK safety lock is located conveniently in the back of the pistol grip. When engaged it prevents firing and disassembling of the GLOCK pistol. The Safety Lock developed by GLOCK is the first safety cylinder lock for pistols worldwide. GLOCK's modern key technology permits the best possible adaptation to your requirements.



KEY AND LOCK:

Intelligent safety provided by the GLOCK pistol cylinder lock. Each key is absolutely unique through state-of-the-art safety technology.

*not upgradeable



FOR INCREASED DIVERSITY



REMOVE THE DARKNESS



GTL 10 & 11

LIGHT MODULE

The Xenon light of the GTL 10 and GTL 11 illuminates targets reliably so they are easy to identify. The GTL housing is made of high quality polymer. Minimal weight and an easily accessible switch makes the GTL 10 and 11 ideal for low light shooting. Designed to work specifically with GLOCK pistols equipped with mounting rails, the GTL 10 and GTL 11 are similar, but with the GTL 11 having an added dimmer function.

A hard storage case made of high resistant polymer as well as a replacement bulb are included with each GLOCK Tactical Light set.



GTL 21 & 22

TACTICAL LIGHT WITH RED LASER

The GTL 21 and the GTL 22 are high-quality products that feature a red (visible) laser which can be zeroed for pinpoint accuracy. The laser functions either independently or in conjunction with the Xenon-light. Light and laser are manipulated by a centrally placed mode-switch. All this is housed in a high-resistant polymer casing. The mounting mechanism allows the user to attach and detach the light in a few seconds without the need for any tools. A hard polymer storage case, a replacement bulb and an adjustment tool for the laser are included with this GLOCK Tactical Light set.

The GTL 22 additionally features a dimmer function, allowing the user to adjust the light intensity as required.



GTL 51 & 52

IR LIGHT AND LASER

The GTL 51 as well as the GTL 52 is a tactical light designed specifically and exclusively for military and law enforcement use. In addition to the Xenon-light and the red dot laser, the GTL 51 and 52 features an IR Light and an IR laser. A centrally placed mode-switch allows for each light or laser to be selected separately or in combination with the others.

The GTL 51 and 52 are similar, but the GTL 52 comes with the additional feature of a dimmable Xenon-light and a dimmable IR laser.

A hard polymer storage case, a replacement bulb and an adjustment tool for the laser is included with this set.



GTL Pouch

CARRY YOUR GTL IN A SAFE WAY!

The GLOCK Tactical light pouch made of sturdy polymer is a fast and secure way to carry your GTL and a set of spare batteries. It fits all GTL models.

GTL Laser filter

REDUCE THE LASER OUTPUT!

The GTL laser filter is designed to reduce the laser and infrared laser output.





Lockable pistol case



SECURED PISTOL STORAGE

The GLOCK lockable pistol case has room for one pistol and is made of durable black polymer and egg-crate foam lines the interior. Two latches snap the case shut securely and a molded-in handle makes transport easy. For additional security there is a key lock integrated in the case which comes with two keys.



1. SAFETY HOLSTER

The GLOCK Safety holster with its sturdy polymer shell design features a locking system which fixes a GLOCK standard size pistol model in the holster and releases it again with the push of a button. Simple design and a reliable locking mechanism are the key to this holster. A thumb-activated cover adds an extra layer of security whenever needed. Carry plates of different dimensions can be attached to any service belt for optimum carry comfort of the GLOCK Safety Holster. This versatile system can be mounted as a light weight thigh holster with the help of the GLOCK Tactical belt hanger.

2. SPORT/DUTY HOLSTER

Fitting your standard size GLOCK pistol like a sleeve, while keeping it firmly in place with the help of a button-held retention strap, this polymer holster is sturdy, protects your firearm from all kinds of dirt and absorbs shock, preventing damage.

The same holster also comes as Military holster with a metal clip, designed specifically for military duty belts.

3. SPORT/COMBAT HOLSTER

This simple yet useful little polymer holster allows the GLOCK pistol to sit close to the body, making it ideal for concealed carrying. The flat shape also makes it comfortable to wear. The holster can be adapted to fit a wide range of different belt-widths.

4. MAGAZINE POUCHES

This belt-mounted black polymer pouch holds a single GLOCK magazine. The ambidextrous magazine pouch will accommodate belt widths up to 63 mm (2.48 in). The design provides retention of the magazine without the need for straps or flaps.

Lanyard Clips & Lanyard

FOR SECURED RETENTION

These polymer lanyard clips with an attachment ring for the lanyard hook are fitted into the frame of the GLOCK pistol.

The GLOCK lanyard easily and effectively secures a pistol by snapping the clip hook into the attachment device of the pistol frame.



Dummy barrels for:

G17



G19



G26



Dummy rounds



Empty chamber flag

Dummies

INCREASED SAFETY FOR TRAINING AND STORAGE

GLOCK Dummy products for training purpose are made of sturdy polymer of orange signal color. GLOCK Dummy rounds function like real ammunition for function drills and come in sets of 50 rounds packed in a black polymer box.



Magazine speed loader

INCREASE YOUR MAGAZINE LOADING SPEED

The GLOCK loading aid included in the standard pistol set simplifies loading even for a larger number of rounds. It has a sturdy design made of GLOCK polymer and slides readily over the GLOCK magazine.



Outdoor

Entrenching tool & Field knives

INNOVATIVE TOOLS FOR ANY PURPOSE

The GLOCK outdoor equipment was specially developed and tested according to army requirements.



Entrenching tool

This lightweight, full-folding spade is the innovative product for the 21st century with many intelligent details.

Material know-how from the pistol development guarantees durability and reliability. A functional tool for any outdoor professional.

Three tools in one product: **Spade, shovel and saw**

Weight: 657 g | 23.2 oz.





GLOCK Field knife FM 78

This classic army knife can be used for any purpose: as a weapon or an outdoor knife, for opening ammunition boxes or bottles. The polymer sheath of this knife is also made by GLOCK.

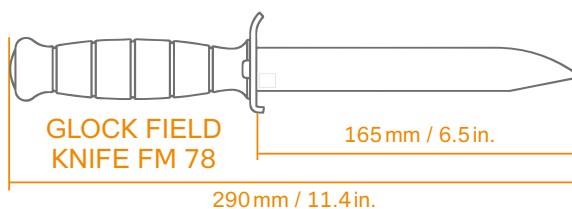

GLOCK Field knife FM 81 (with saw)

In addition to the convincing characteristics of the FM 78, the field knife FM 81 is equipped with a sturdy saw at the back of the blade and a polymer sheath.

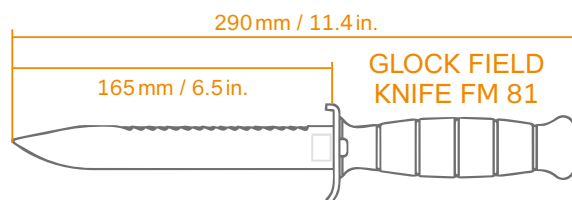

AVAILABLE COLORS:

black, battle field green, flat dark earth and grey





GLOCK Armorer's Course

ATTENDING THE GLOCK ARMORER'S COURSE WILL MAKE YOU A CERTIFIED GLOCK ARMORER

GLOCK trainers will familiarize you with the nomenclature of the GLOCK pistol. You will learn the skills required for practical use. Performing service and maintenance operations as well as the functioning of the SAFE ACTION® system will be demonstrated together with all safety precautions.

Upon completion of the GLOCK Armorer's Course, and satisfactory grade on a practical and written exam, you will receive a certificate as a GLOCK Armorer. This will entitle you to carry out maintenance operations and GLOCK approved modifications on GLOCK pistols.

CONTENTS:

Professional know-how concerning the individual components of the GLOCK pistol as well as disassembling and installing the various GLOCK options.

CONTACT:

Public law enforcement agencies are requested to contact their local GLOCK representative. For contact details visit www.glock.com

GLOCK armorer's courses are not offered to private individuals.





Are you looking for a GLOCK Partner?

With over 50 different models, any GLOCK purchase can be a bit confusing with options ranging from different calibers, sizes, generations and dozens of options for modifying your GLOCK.

With the GLOCK Partners a pool of retailers was created, who know their GLOCKS and help hundreds of customers in choosing their perfect model.



For more details visit www.glock.com



SHOW YOUR PASSION FOR GLOCK!

Fan Items

GET YOUR STYLE WITH GLOCK!

Our GLOCK partners offer a variety of fan items for passionate GLOCK fans.

Check out our official GLOCK collection on www.glock.com



COURIER BAG



SPORTS BOTTLE



G17 CAP





World of GLOCK

Fan Items



LIGHT SOFT-SHELL JACKET



BATH TOWEL II

CONTACT:

For more detailed information on our products refer to www.glock.com or contact your local GLOCK dealer.

MEDIA OWNER, PUBLISHER:

GLOCK Ges.m.b.H.
Gaston Glock-Platz 1,
2232 Deutsch-Wagram
Austria

PICTURES:

The pictures in this brochure are symbolic pictures and might differ from the actual product.

PRINT:

sandler print&packaging
Johann Sandler GesmbH & Co KG,
Druckereiweg 1, 3671 Marbach/Donau
Austria

Technical and measurement changes as well as misprints in graphic or writing reserved.

www.glock.com